



TS/R-2A

INSTALLATION AND OPERATING INSTRUCTIONS

IF YOU CANNOT READ OR UNDERSTAND THESE INSTALLATION INSTRUCTIONS DO NOT ATTEMPT TO INSTALL OR OPERATE

INTRODUCTION

This SKYTECH remote control system was developed to provide a safe, reliable, and user-friendly remote control system for gas heating appliances. The system can be operated thermostatically or manually from the transmitter. The system operates on radio frequencies (RF) within a 20' range using non-directional signals. The system operates one of 65,536 security codes that are programmed into the transmitter at the factory; the remote receiver's code must be matched to that of the transmitter prior to initial use.

Review **COMMUNICATION SAFETY SECTION** under TRANSMITTER section and **THERMO SAFETY SECTION** under REMOTE RECEIVER section. These signal/temperature safety features shut down the fireplace system when a potentially unsafe condition exists.

WALL MOUNT THERMOSTAT

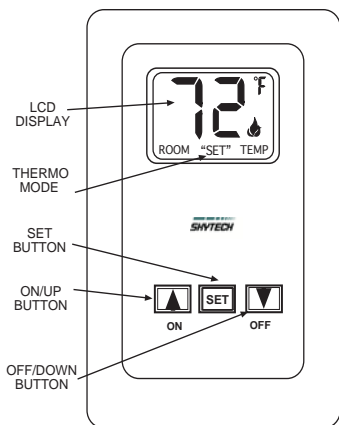

The wall/transmitter operates on (2) 3V Button Cell (Included) which powers the LCD screen and powers the RF signal. These batteries are made specifically for remote controls and electronic lighters. Before using the transmitter the 3V batteries must be installed into the battery compartments.

It is recommended that CR2032 lithium batteries always be used for longer battery life and maximum operational performance.

Upon initial use, there may be a delay of five seconds before the remote receiver will respond to the transmitter. This is part of the system's design. If the LCD screen will not come on, check the 3V Button Cell battery.

TO INSTALL BATTERIES IN THE WIRELESS THERMOSTAT

1. Remove face from backing plate This is done by sliding the face up about 1/2" then pull the face off the base plate. As shown in Figure #1
2. Locate the (2) holders for the 3V button cell batteries.
3. Slide the button cell batteries into the battery holders. (Make sure that the batteries are installed with the (+) plus side facing you or up.

TO REMOVE THE BATTERIES IN THE WIRELESS THERMOSTAT

1. Remove face from backing plate This is done by sliding the face up about 1/2" then pull the face off the base plate. As shown in Figure #1
2. Locate the (2) holders for the 3V button cell batteries.
3. Insert a small screwdriver into the slot above the button cell battery and push the battery out. AS shown in Figure #2

Figure #1

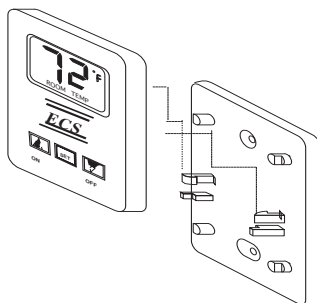
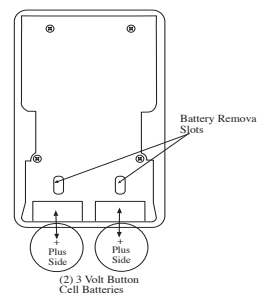

Figure #2

BACK OF UNIT



WALL MOUNTING THE THERMOSTAT

1. The wireless Thermostat must be located within 20' of the receiver, This is the normal operational distance.
2. Remove face from backing plate as shown in **Figure #1** then locate the (2) two holes that mount the plate to the wall.
3. After locating the (2) two mounting holes and mark the holes on the wall.
4. Use the (2) two dry wall anchors and screws (that are supplied) to mount the base plate to the wall as shown.
5. Thermostat can also be mounted onto an existing (Plastic) electrical box.
6. Base plate should be mounted level on the wall for best operation.

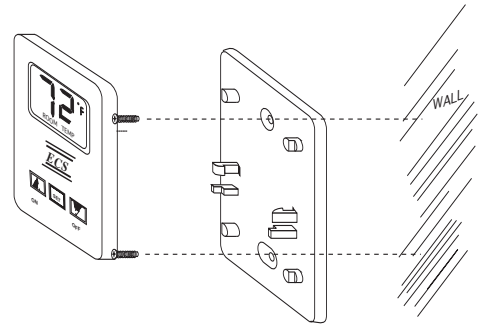

GENERAL INFORMATION

WALL MOUNT THERMOSTAT OPERATION

FUNCTIONS

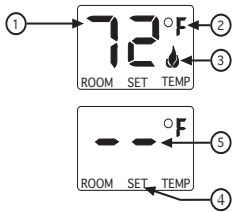

1. ROOM TEMP – Current room temperature.
2. **F** – Degrees Fahrenheit (**C** Indicates degrees Celsius)
3. FLAME ICON – Indicates APPLIANCE IS ON.
4. SET- Indicates transmitter is in thermostat mode.
5. DASHES – Indicate thermostat mode is being disabled. When transmitter is not in the thermostat mode. The word (**SET**) will not appear.



1. This TS/R-2-A Wall/transmitter has **ON**, **OFF**, and **SET** functions that are activated by pressing the buttons on the face of the transmitter.
2. Upon initial use, there may be a delay of five seconds before the remote receiver will respond to the transmitter. This is part of the system's design. If the LCD will not come on, check the 3V-button cell battery.

SETTING MANUAL OPERATION



1. When the **ON** button on the wall/transmitter is pressed a flame icon on the LCD screen will appear when the appliance is **ON**.
2. When the appliance is **OFF** the flame icon will not appear.

SETTING THERMOSTAT OPERATION

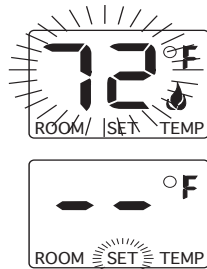

1. If the transmitter is in the thermostat mode the word (**SET**) will appear on the LCD screen.
2. When the **SET** button is pressed the temperature digits will begin to flash.
3. While the temperature digits are flashing use the **ON** button to increase the set temperature or use the **OFF** button to decrease the set temperature to your desired temperature.
4. When the desired temperature setting is reached press the **SET** button, again and the word **SET** will appear on the LCD screen and now the transmitter will automatically send an **ON** or **OFF** signal to the receiver.
5. To disengage the thermostat mode push the **OFF** button or push and hold the **SET** button until (2) dashes appear on the LCD screen. When you release the **SET** button this will disengage the thermostat mode and the word **SET** will disappear from the LCD screen.

SETTING °F / °C SCALE

The factory setting for temperature is degrees Fahrenheit (°F). To change this setting to Centigrade (°C), you must press and hold both the **ON** and **OFF** buttons on the transmitter **at the same time** until the LCD displays the change. If you want to convert back, repeat the above procedure.

THERMO UPDATING FEATURE – TRANSMITTER – (T/S – TX)

This SKYTECH remote control has a THERMO UPDATING Feature built into its software. The THERMO UPDATING Feature operates in the following manner, but only in the THERMO MODE:

The transmitter normally reads the ROOM temperature every 2 minutes checking the ROOM temperature against the SET temperature and then sends a signal to the receiver.

COMMUNICATION – SAFETY – TRANSMITTER – (C/S – TX)

This SKYTECH remote control has a COMMUNICATION –SAFETY function built into its software. It provides an extra margin of safety when the TRANSMITTER is out of the normal 20 foot operating range of the receiver.

The COMMUNICATION – SAFETY feature operates in the following manner, in all OPERATING MODES – Manual ON and THERMO.

At all times and in all OPERATING MODES, the wall transmitter sends an RF signal every fifteen (15) minutes, to the receiver, Should the receiver NOT receive a transmitter signal every 15 minutes, the IC software, in the RECEIVER, will begin a 2-HOUR (120-minute) countdown timing function. If during this 2-hour period, the receiver does not receive a signal from the wall transmitter, the receiver will shut down the appliance being controlled by the receiver. The RECEIVER will then emit a series of rapid “beeps” for a period of 10 seconds. Then after 10 seconds of rapid beeping, the RECEIVER will continue to emit a single “beep” every 4 seconds until the ON button on the wall transmitter is pressed to reset the receiver. The intermittent 4 second beeping will go on for as long as the receiver’s batteries last which could be in excess of one year.

To “reset” the RECEIVER and operate the appliance, you must press ON button on the wall transmitter. The flame icon must be display on the LCD screen. By turning the system to ON, the COMMUNICATION -SAFETY operation is overridden and the system will return to normal operation depending on the MODE selected at the wall transmitter. The COMMUNICATION – SAFETY feature will reactivate if the transmitter’s batteries fail or be removed.

REMOTE RECEIVER

The remote receiver operates on 4 AA-size 1.5V batteries. It is recommended that ALKALINE batteries be used for longer battery life and maximum microprocessor performance. **IMPORTANT:** New or fully charged batteries are essential for proper operation of the remote receiver.

The remote receiver houses the microprocessor that responds to commands from the transmitter to control system operation. It emits one beep when it receives an ON or OFF command manually, but no beep when cycling on and off automatically in THERMO mode. The remote receiver has a 3-position slide switch for selecting the MODE of operation: ON/REMOTE/OFF

- With the slide switch in the ON position (toward the LEARN button), the system will remain on until the slide switch is placed in the OFF or REMOTE position.
- With the slide switch in the REMOTE position (centered), the system will only operate if the remote receiver receives commands **from the transmitter**.
- With the slide switch in the OFF position (away from the LEARN button), the system is off.
- It is suggested that the slide switch be placed in the off position if you will be away from your home for an extended period of time. If the remote receiver is mounted out of children’s reach, placing the slide switch in the OFF position also functions as a safety “lock-out” by both turning the system off and rendering the remote receiver inoperative.

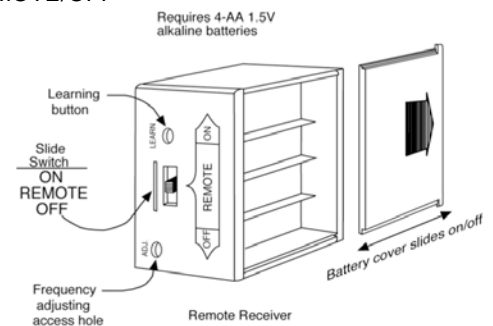

THERMO- SAFETY FEATURE – RECEIVER (T/S –RX)

This SKYTECH remote control has a THERMO- SAFETY feature that is built into the system’s RECEIVER. This feature is temperature- activated and provides an extra margin of safety when the RECEIVER is operating where ambient temperatures exceed 130 ° F degrees inside the receiver case.

The THERMO-SAFETY feature, in the RECEIVER, operates in the following manner, when the appliance is in operation.

The receiver is thermally protected from extreme heat conditions. Heat can have negative effect on the operation of the receiver’s microprocessors.

For REMOTE RECEIVERS that operate on BATTERY POWER, these heat conditions can cause batteries to discharge when temperatures exceed 115⁰ F. Studies show that alkaline batteries, when exposed to a constant temperature of 120⁰ F, can lose up to 50% of their operating power. When the battery cools down, it will partially recharge itself, but constant heating and cooling will reduce the battery's normal life expectancy.

When the ambient temperature at the THERMISTOR, *inside the receiver case*, reaches 130⁰ F, the THERMISTOR will automatically shut the appliance down and the RECEIVER will begin emitting a series of 2 "beeps", every 4 seconds. When the ambient temperature, at the RECEIVER, drops between 120⁰ F and 130⁰ F, the user can reactivate the appliance by pushing the MODE button on the transmitter. The word ON must display on the LCD screen. When the ON button is pressed, the wall THERMISTOR "resets" itself and the fireplace will begin operating again. However, the "beeping" will continue, if the ambient temperature remains between 120⁰ F and 130⁰ F. This "beeping" alerts the user that the RECEIVER should be repositioned so the ambient temperature drops below 120⁰ F.

When the temperature drops below 120⁰ F, the "beeping" will cease, providing the user has "reset" the THERMISTOR by pushing the MODE button to ON to operate the appliance, either manually or thermally. Allow sufficient time for the receiver to cool below 120⁰ F, and then press MODE button to stop beeping.

INSTALLATION INSTRUCTIONS

WARNING

This remote control system must be installed exactly as outlined in these instructions. Read all instructions completely before attempting installation. Follow instructions carefully during installation. Any modifications of the SKYTECH remote control or any of its components will void the warranty and may be pose a fire hazard.

Do not connect any gas valve or electronic module directly to 110-120VAC power. Consult gas appliance manufacturer's instructions and wiring schematics for proper placement of all wires. All electronic modules are to be wired to manufacturer's specifications.

The following wiring diagrams are for illustration purpose only. Follow instructions from manufacturer of gas valve and/or electronic module for correct wiring procedures. Improper installation of electric components can cause damage to electronic module, gas valve and remote receiver.

INSTALLATION

The remote receiver can be either wall-mounted in a standard plastic switch box or placed on or near the fireplace hearth. Preferably, the remote receiver should be wall-mounted in a plastic switch box, as this will protect its electronic components from both the heat produced by the gas appliance and potential damage or abuse that can occur if it is left exposed on the hearth. **PROTECTION FROM EXTREME HEAT IS VERY IMPORTANT.** Like any piece of electronic equipment, the remote receiver should be kept away from temperatures exceeding 130⁰ F inside the receiver case. Battery life is also significantly shortened if batteries are exposed to high temperatures.

Make sure the remote receiver switch is in the OFF position. It is recommended that 18 gauge stranded or solid wires (included) be used to make connections between the terminal wiring block on the millivolt gas valve or electronic module and the wire terminals on the remote receiver. For the best results, use 18 gauge stranded or solid wire, with no splices and measuring no longer than 20 ft.

WALL MOUNTING

Install 4 AA-size 1.5 ALKALINE batteries in the remote receiver. For best performance, remote receiver batteries should be factory fresh when installed. Very little battery power is required to operate the remote receiver, but the electronics are tuned to operate best when battery output is greater than 5.3 volts. Four new AA batteries should provide an output voltage of 6.0 to 6.2 volts. **Be sure batteries are installed with the (+) and (-) ends facing the correct direction.**

To attach wall cover plate to receiver box:

1. Position the receiver as shown in diagram to the left with lower tab on wall cover plate into groove of receiver (Make sure ADJ hole and LEARN hole on cover plate properly aligns with remote receiver)
2. Pull receiver up and snap into top tab of cover plate.
3. Position the wall cover plate so the word ON is facing up.
4. Install the remote receiver into the plastic switch box using the two long screws provided. Push the slide Button over the receiver slide switch only after making sure the remote receiver has LEARNED the transmitter's security code (see MATCHING SECURITY CODES).

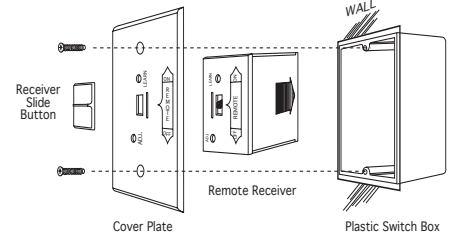
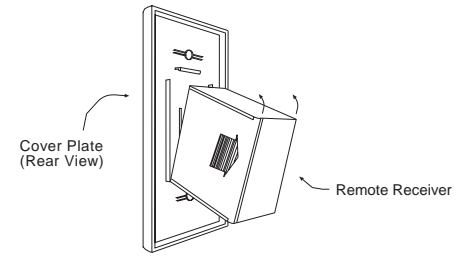

NOTE: The remote receiver will only respond to the transmitter when the 3-position slide button on the remote receiver is in the REMOTE position. If the system does not respond to the battery transmitter on initial use, see MATCHING SECURITY CODES, and recheck battery positions in the remote receiver.

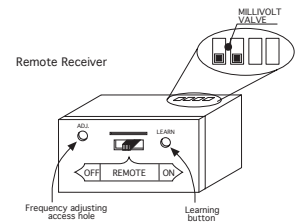

HEARTH MOUNT

The remote receiver can be placed on the fireplace hearth or under the fireplace, behind the control access panel. Position where the ambient temperature inside the receiver case does not exceed 130⁰ F.

NOTE: Black Slide Button is used for Hearth Mount applications.

WIRING INSTRUCTIONS

A qualified electrician or a gas technician who is familiar with the gas appliance and gas valves that will be operated by this remote should install the remote control system. Incorrect wiring connections **WILL** cause damage to the gas valve or electronic module operating the gas appliance and may also damage the remote receiver.

WIRING MILLIVOLT VALVES

The remote receiver is connected to the millivolt valve using the TH (thermostat) terminals on the terminal block on the millivolt gas valve. Connect 18 gauge stranded or solid wires from the remote receiver to the gas valve.

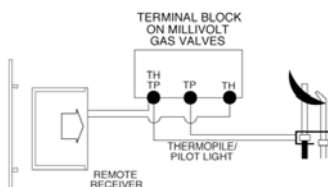

Operation of the remote receiver is similar to that of a thermostat in that both turn the gas valve on and off based on input signals. A thermostat's input signals are different temperatures. The remote receiver's input signals come from the transmitter.

Connect each of the two wires leading from the TH and TH/TP terminals on the millivolt gas valve to either of the two wire terminals on the remote receiver. Normally it does not matter which wires go to which terminal.

WIRING ELECTRONIC SPARK IGNITIONS

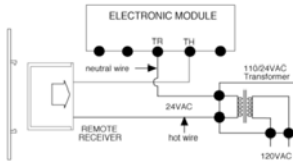

The remote control receiver can be connected, in series, to a 24VAC transformer to the TR (transformer) terminal on the ELECTRONIC MODULE. Connect the hot wire from the 24VAC transformer to either of the wire terminals on the remote receiver. Connect another wire (Not included) between the other receiver wire terminal and the TH (thermostat) terminal on the ELECTRONIC MODULE.

SYSTEM CHECK

MILLIVOLT VALVES

Light your gas appliance following the lighting instructions that came with the appliance. Confirm that the pilot flame is on; it must be in operation for the main gas valve to operate.

- Slide the 3-position button on the remote receiver to the ON position. The main gas flame (i.e., the fire) should ignite.
- Slide the button to OFF. The flame should extinguish (the pilot flame will remain on).
- Slide the button to REMOTE (the center position), then press the **ON** button on the transmitter to change the system to ON. The main gas flame should ignite.
- Press the **ON** button on the wall transmitter to change the system to OFF. The flame should extinguish (the pilot flame will remain on).
- Press the **ON** button on the wall transmitter to change the system to THERMO. Advance the SET temperature on the transmitter to a temperature of at least 2° F (1° C) above the ROOM temperature displayed on the LCD screen. With this manual setting, the normal thermostatic cycle is overridden and the system flame will ignite. Set the SET temperature to at least 2° F (1° C) below the room temperature and the system flame will extinguish in a few seconds. Thereafter, it should continue to cycle to on and off thermostatically approximately every two minutes as the ROOM temperature changes, but only when the temperature differential between ROOM and SET temperatures differ at least 2° F (1° C). The 2° F differential is the factory setting.

ELECTRONIC IGNITION SYSTEMS

- Slide the 3-position button on the remote receiver to the ON position. The spark electrode should begin sparking to ignite the pilot (the pilot may ignite after only one spark). After the pilot flame is lit, the main gas valve should open and the main gas flame should ignite.
- Slide the button to OFF. The main gas flame and pilot flame should BOTH extinguish.
- Slide the button to REMOTE (the center position), then press the **ON** button on the wall transmitter to change the system to ON. The spark electrode should begin sparking to ignite the pilot. After the pilot is lit, the main gas valve should open and the main gas flame should ignite.
- Press the **ON** button on the wall transmitter to OFF. The main gas flame and pilot flame should BOTH extinguish.
- Press the **ON** button on the wall transmitter to change the system to THERMO. Advance the SET temperature on the transmitter to a temperature of at least 2° F (1° C) above the ROOM temperature displayed on the LCD screen. With this manual setting the normal thermostatic cycle is overridden and the system flame will ignite. Set the SET temperature to at least 2° F (1° C) below the room temperature and the system flame will extinguish in a few seconds. Thereafter, it should continue to cycle to on and off thermostatically approximately every two minutes as the ROOM temperature changes, but only when the temperature differential between ROOM and SET temperatures differ at least 2° F (1° C). (The 2° F differential is the factory setting).

GENERAL INFORMATION

MATCHING SECURITY CODES

Each transmitter can use one of 65,536 unique security codes. It may be necessary to program the remote receiver to LEARN the security code of the transmitter upon initial use, if batteries are replaced, or if a replacement transmitter is purchased from your dealer or the factory. When matching security codes, be sure slide button on the receiver is in the REMOTE position; the code will NOT "LEARN" if the slide switch is in the ON or OFF position. Program the remote receiver to LEARN a new security code by pushing in the LEARN button on the top of the remote receiver and then pressing the **ON** button on the wall transmitter. A change in the beeping pattern, at the receiver, indicates the transmitter's code has been programmed into the receiver. When an existing receiver is matched to a new transmitter, the new security code will override the old one.

The microprocessor that controls the security code matching procedure is controlled by a timing function. If you are unsuccessful in matching the security code on the first attempt, wait 1-2 minutes before trying again – this delay allows the microprocessor to reset its timer circuitry – and try up to two or three more times.

THERMO FUNCTION

When the transmitter is in the THERMO mode, it should be kept away from direct sources of heat such as fireplaces, incandescent lighting, and direct sunlight. Leaving the transmitter in direct sunlight, for example, will cause its heat-sensing diode to read the room temperature higher than it actually is; if in THERMO mode, it may not turn on the appliance even if the ambient ROOM temperature is below the SET temperature.

BATTERY LIFE

Life expectancy of alkaline batteries in the SKYTECH A-TS/R-2A should be at least 12 months. Check and replace all batteries annually. When the Wall Transmitter no longer operates or the remote receiver does not function at all, the batteries should be checked. It is important that the remote receiver batteries are fully charged, providing a combined output voltage of at least 5.3 volts. The length of the wire between the remote receiver and the gas valve directly affects the operating performance of the remote system. The longer the wire, the more battery power is required to deliver signals between the remote receiver and the gas valve. The Wall Transmitter should operate with as little as 2.4 volts of battery power, measuring at each of the 3 volt button cell batteries.

TROUBLE SHOOTING

Should you encounter problems with your fireplace system, the problem may be with the fireplace itself or it could be with the SKYTECH remote control. Review the fireplace manufacturer's operation manual to make sure all connections are properly made. Then check the operation of the SKYTECH remote in the following manner:

1. Make sure receiver batteries are installed properly. If one battery is installed backward, receiver will not operate in remote mode. Be sure battery output is 5.3 volts or more. (Slide switch is independent of battery condition.)
2. Be sure the wall transmitter's batteries are properly installed and that the battery output is 2.4 volts each or more.
3. The wall transmitter has (2) 3 volt button cell batteries (1) button cell operates the LCD screen and the other button cell operates sending the RF signal. If the button cell battery that controls sending the RF signal is low or defective the LCD screen may work but the RF signal may not be sending (Check each button cell battery)
4. Check to make sure the transmitter is communicating with the receiver.
 - If the receiver beeps when the **ON** button is depressed on the wall transmitter they are communicating.
 - If the receiver does not beep when the **ON** button is depressed on the wall transmitter, you will need to teach the receiver the code of the transmitter. This is done by holding the **LEARN** button down on the receiver (NOTE: The black slide Button covers the LEARN access hole when installed), and at the same time depress the ON button on the wall transmitter. A change in the beeping pattern, at the receiver indicates the transmitter's code has been programmed into the receiver.
5. Make sure the wall transmitter is within the 15'-20' range of the receiver.
6. Positioning of the receiver is important. If the receiver is "enclosed" in a metal surround, the operation of the receiver may be affected as noted below. Reposition the receiver to improve operating range. It is suggested that a heat shield be installed to protect the receiver from extreme heat. If the receiver is "enclosed" in a metal surround, this can:
 - Cause the RF signal to get lost and not communicate with the receiver.
 - Cause the working distance to be shorter than normal.

NOTE: A receiver located in an area, where the ambient temperature inside the case exceeds 130 °F, will cause THERMO-SAFETY feature to cut in, requiring you to reposition the receiver to stop the warning beeps, and to "reset" the receiver's operation.
7. Due to handling and shipping of the unit, handling or dropping of the wall transmitter by the customer, and heat conditions to the receiver, some units may need an occasional frequency adjustment. This adjustment is made to improve the communication and operating distance between the transmitter and the receiver. See RECEIVER ADJUSTMENT.

RECEIVER ADJUSTMENT – RECOMMENDED ADJUSTMENT

NOTE: The black slide button covers the ADJ access hole when installed.

- A. To adjust at the receiver, use a small slotted screwdriver. Turn the adjustment screw counter-clockwise about 5 degrees or a maximum of 1/8 turn. This should correct the distance problem.
- B. If that does not correct the problem, return adjustment screw to original position and then turn adjustment screw clockwise.

This adjustment is like tuning your radio. If you keep turning the adjustment screw, in either direction, you will go past the proper setting (tuning).

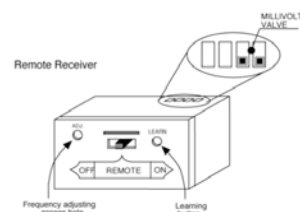

SPECIFICATIONS

BATTERIES: Wall Transmitter 6 – 2ea. (CR2032) 3.0 volt lithium button cell batteries
Remote Receiver 6V –4ea. AA 1.5 Alkaline FCC ID No.'s: transmitter –(K9L TS-R-2A); receiver – (K9L 3001RX)
Operating Frequency: 303.8MHZ Canadian IC ID No.'s: transmitter – (2439A-TSR2A) receiver – 2439-102-760A

FCC REQUIREMENTS

NOTE: THE MANUFACTURER IS NOT RESPONSIBLE FOR ANY RADIO OR TV INTERFERENCE CAUSED BY UNAUTHORIZED MODIFICATIONS TO THIS EQUIPMENT. SUCH MODIFICATIONS COULD VOID THE USER'S AUTHORITY TO OPERATE THE EQUIPMENT.

WARRANTY

All warranty information is listed on the warranty sheet packed with this product. If you did not receive this warranty sheet, please contact Skytech Systems, Inc. at the following:
9230 Conservation Way, Fort Wayne, IN 46809
(888) 672-8929 or (260) 459-1703

FOR TECHNICAL
SERVICE, CALL:

U.S. INQUIRIES
888/672-8929 or
260/459-1703
Website: skytechsystem.com

CANADIAN INQUIRIES
877-472-3923

MANUFACTURED EXCLUSIVELY FOR SKYTECH II, INC